

PR
electronics



5725

**Programmable
frequency indicator**

No. 5725V102-UK

From ser. no. >121435001



ERC

CE

- DK** ▶ PR electronics A/S tilbyder et bredt program af analoge og digitale signalbehandlingsmoduler til industriel automation. Programmet består af Isolatorer, Displays, Ex-barrierer, Temperaturtransmittere, Universaltransmittere mfl. Vi har modulerne, du kan stole på i selv barske miljøer med elektrisk støj, vibrationer og temperaturudsving, og alle produkter opfylder de strengeste internationale standarder. Vores motto »Signals the Best« er indbegrebet af denne filosofi - og din garanti for kvalitet.
- UK** ▶ PR electronics A/S offers a wide range of analog and digital signal conditioning devices for industrial automation. The product range includes Isolators, Displays, Ex Interfaces, Temperature Transmitters, and Universal Devices. You can trust our products in the most extreme environments with electrical noise, vibrations and temperature fluctuations, and all products comply with the most exacting international standards. »Signals the Best« is the epitome of our philosophy - and your guarantee for quality.
- FR** ▶ PR electronics A/S offre une large gamme de produits pour le traitement des signaux analogiques et numériques dans tous les domaines industriels. La gamme de produits s'étend des transmetteurs de température aux afficheurs, des isolateurs aux interfaces SI, jusqu'aux modules universels. Vous pouvez compter sur nos produits même dans les conditions d'utilisation sévères, p.ex. bruit électrique, vibrations et fluctuations de température. Tous nos produits sont conformes aux normes internationales les plus strictes. Notre devise »SIGNALS the BEST« c'est notre ligne de conduite - et pour vous l'assurance de la meilleure qualité.
- DE** ▶ PR electronics A/S verfügt über ein breites Produktprogramm an analogen und digitalen Signalverarbeitungsgeräte für die industrielle Automatisierung. Dieses Programm umfasst Displays, Temperaturtransmitter, Ex- und galvanische Signaltrenner, und Universalgeräte. Sie können unsere Geräte auch unter extremen Einsatzbedingungen wie elektrisches Rauschen, Erschütterungen und Temperaturschwingungen vertrauen, und alle Produkte von PR electronics werden in Übereinstimmung mit den strengsten internationalen Normen produziert. »Signals the Best« ist Ihre Garantie für Qualität!

PROGRAMMABLE FREQUENCY INDICATOR 5725

CONTENTS

Warning.....	2
Safety instructions.....	3
Front and back layout.....	5
Application.....	6
Technical characteristics.....	6
Mounting / installation.....	7
Application.....	8
Order: 5725.....	9
Electrical specifications.....	9
Sensor error indication, inside and outside range	13
Connections	15
Block diagram.....	16
Configuration / operating the function keys.....	17
Password protection.....	18
Additional 5725 features (from s/n > 121435001).....	18
Routing diagram for 5725A	19
Routing diagram for 5725D	21
Scrolling help texts.....	23
Graphic depiction of the relay function setpoint.....	25



GENERAL

WARNING

This device is designed for connection to hazardous electric voltages. Ignoring this warning can result in severe personal injury or mechanical damage. To avoid the risk of electric shock and fire, the safety instructions of this manual must be observed and the guidelines followed. The specifications must not be exceeded, and the device must only be applied as described in the following. Prior to the commissioning of the device, this manual must be examined carefully. Only qualified personnel (technicians) should install this device.

If the equipment is used in a manner not specified by the manufacturer, the protection provided by the equipment may be impaired.



**HAZARDOUS
VOLTAGE**



WARNING

Until the device is fixed, do not connect hazardous voltages to the device.

The following operations should only be carried out on a disconnected device and under ESD safe conditions:

Troubleshooting the device.

Repair of the device must be done by PR electronics A/S only.

SYMBOL IDENTIFICATION



Triangle with an exclamation mark: Warning / demand. Potentially lethal situations.



The CE mark proves the compliance of the device with the essential requirements of the directives.

SAFETY INSTRUCTIONS

DEFINITIONS

Hazardous voltages have been defined as the ranges: 75 to 1500 Volt DC, and 50 to 1000 Volt AC.

Technicians are qualified persons educated or trained to mount, operate, and also troubleshoot technically correct and in accordance with safety regulations.

Operators, being familiar with the contents of this manual, adjust and operate the knobs or potentiometers during normal operation.

RECEIPT AND UNPACKING

Unpack the device without damaging it. The packing should always follow the device until this has been permanently mounted. Check at the receipt of the device whether the type corresponds to the one ordered.

ENVIRONMENT

Avoid direct sunlight, dust, high temperatures, mechanical vibrations and shock, as well as rain and heavy moisture. If necessary, heating in excess of the stated limits for ambient temperatures should be avoided by way of ventilation.

All devices fall under Installation Category II, Pollution Degree 2, and Insulation Class II.

MOUNTING

Only technicians who are familiar with the technical terms, warnings, and instructions in the manual and who are able to follow these should connect the device.

Should there be any doubt as to the correct handling of the device, please contact your local distributor or, alternatively,

PR electronics A/S
www.prelectronics.com

Mounting and connection of the device should comply with national legislation for mounting of electric materials, i.e. wire cross section, protective fuse, and location. Descriptions of Input / Output and supply connections are shown in the block diagram and side label.

The following apply to fixed hazardous voltages-connected devices:

The max. size of the protective fuse is 10 A and, together with a power switch, it shall be easily accessible and close to the device. The power switch shall be marked as the disconnecting unit for the device.

UL INSTALLATION REQUIREMENTS

For use on a flat surface of a type 1 enclosure.

Use 60/75°C copper conductors only.

Enclosure rating (face only)..... Type 4X, UL50E

Max. ambient temperature 60°C

Max. wire size, pins 41...46 AWG 30-16

Max. wire size, others AWG 30-12

UL file number E248256

CALIBRATION AND ADJUSTMENT

During calibration and adjustment, the measuring and connection of external voltages must be carried out according to the specifications of this manual. The technician must use tools and instruments that are safe to use.

NORMAL OPERATION

Operators are only allowed to adjust and operate devices that are safely fixed in panels, etc., thus avoiding the danger of personal injury and damage. This means there is no electrical shock hazard, and the device is easily accessible.

CLEANING

When disconnected, the device may be cleaned with a cloth moistened with distilled water.

LIABILITY

To the extent the instructions in this manual are not strictly observed, the customer cannot advance a demand against PR electronics A/S that would otherwise exist according to the concluded sales agreement.

FRONT AND BACK LAYOUT



Picture 1: Front of 5725.

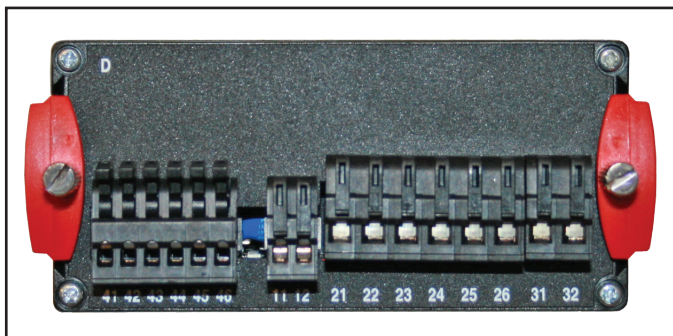

Picture 2: Back of 5725.

PROGRAMMABLE FREQUENCY INDICATOR 5725

- *Measures NPN, PNP, Contact, NAMUR, SO, Tacho and TTL sensors*
- *Programmable frequency input span of 0.001 Hz to 50 kHz*
- *The 5725D has two SPDT relays and one analog output*
- *Easy to read 4 digit, 14 segment LED display with scrolling help text*
- *Universally powered by 21.5...253 VAC or 19.2... 300 VDC*

Application

- The 5725 measures, scales, and displays frequency signals found in many process speed and flow rate applications.
- The indicator can measure the period of the frequency, useful for displaying the elapsed time between events.
- The 5725D has two SPDT setpoint contacts and a 0/4...20 mA output for process control.
- The installed display provides IP65 environmental sealing, and additional protection is provided by the optional 8335 splash proof cover.

Technical characteristics

- 4 digit display w/13.8 mm high, 14 segment LED digits and adjustable decimal point.
- Indicator is scalable from -1999 to 9999
- Scrolling help text makes programming easy.
- Built-in excitation source for measuring NPN, PNP, NAMUR and SO sensors.
- Fast response time of 1 cycle + 100 mS, and excellent accuracy of better than 0.05% of selected range.
- The analog output current on the 5725D can be dampened from 0.1 to 60 seconds, and can handle up to 800 Ohms loop load.

- The 5725 meets NAMUR NE21 recommendations, for high performance in harsh EMC environments.
- High 2.3 kVAC galvanic isolation, and an excellent signal/noise ratio of > 60dB.

Mounting / installation

- Easy to mount 1/8 DIN (48 x 96 mm) panel meter with IP65, (type 4X) sealing.
- Approved for marine applications.
- Fully push-button programmable.
- Password protected.

APPLICATION

Input signals:

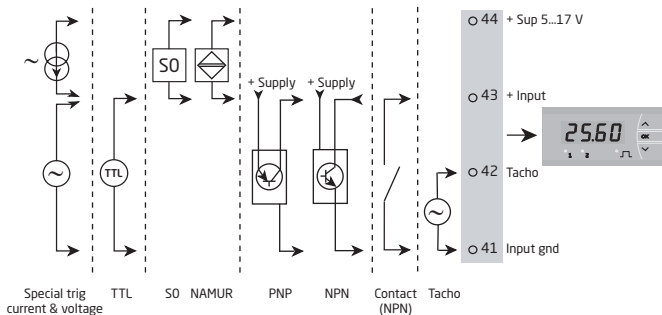

Output signals:

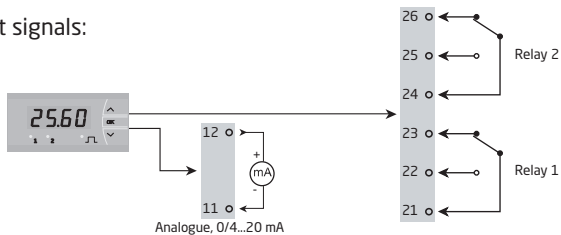

Supply:

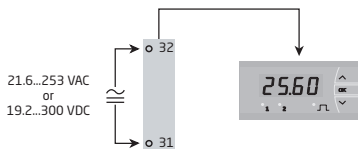

Order: 5725

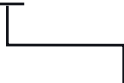

Type	Version
5725	Standard.....: A
	Analog output and 2 relays: D

Accessories:

8335 = Splash proof cover

Electrical specifications

Environmental conditions:

Specifications range..... -20°C to +60°C
Storage temperature -40°C to +85°C
Calibration temperature 20...28°C
Relative humidity..... < 95% RH (non-cond.)
Protection degree..... IP20
Installation in pollution degree 2 & measurement / overvoltage category II.

Mechanical specifications:

Dimensions (H x W x D)..... 48 x 96 x 120 mm
Cutout dimensions 44.5 x 91.5 mm
Protection degree (mounted in panel)..... IP65 / Type 4X, UL50E
Weight 230 g
Wire size, pin 11-12 & 41-44, max..... 1 x 1.5 mm²/
AWG 30...16 stranded wire
Wire size, others, max..... 1 x 2.5 mm²/
AWG 30...12 stranded wire
Terminal connection Spring-cage
Vibration IEC 60068-2-6 Test FC
2...13.2 Hz ±1 mm
13.2...100 Hz ±0.7 g

Common electrical specifications:

Supply voltage, universal	21.6...253 VAC, 50...60 Hz or 19.2...300 VDC
Power consumption, 5725A / 5725D	< 2.8 W / < 3.6 W
Isolation voltage, test / operation	2.3 kVAC / 250 VAC
Signal / noise ratio	> 60 dB

Input specifications:

Frequency range,	
f/I conversion function	0.001 Hz to 50 kHz
Low cut off frequency (default value)	0.0009 Hz
Low cut off frequency, (LCOF=YES)	0.5 Hz (2 s)
Max. frequency, with input filter ON	50 Hz
Time range, period time function	999.9 s to 20 μ s
Low cut off period time	1111 s
Min. period time with input filter ON	20 ms
Response time (0...90%, 100...10%)	< 1 period + 100 ms

Accuracy values		
Specification	Absolute accuracy	Temperature coefficient
Input to Display & Relays	$\leq \pm 0.05\%$	$\leq \pm 0.01\% / ^\circ\text{C}$
Input to Analog Output	$\leq \pm 0.1\%$	

EMC immunity influence	< $\pm 0.5\%$ of span
Extended EMC immunity: NAMUR NE 21, A criterion, burst	< $\pm 1\%$ of span

Input types:**NAMUR input - acc. to EN 60947-5-6:**

Trig-level LOW	≤ 1.2 mA
Trig-level HIGH	≥ 2.1 mA
Input impedance	1 k Ω / < 1.5 nF
Breakage detection	≤ 0.1 mA
Short-circuit detection	≥ 6.9 mA
Sensor supply - pin 44, fixed	8.3 V

Tacho input:

Trig-level LOW	$\leq - 50 \text{ mV}$
Trig-level HIGH.....	$\geq + 50 \text{ mV}$
Input impedance	$\geq 100 \text{ k}\Omega / < 1.5 \text{ nF}$
Max. input voltage	80 VAC pp
Sensor supply - pin 44, programmable	$5...17 \text{ V} / 20 \text{ mA}$

NPN / PNP input:

Trig-level LOW	$\leq 4.0 \text{ V}$
Trig-level HIGH.....	$\geq 7.0 \text{ V}$
Input impedance	$3.48 \text{ k}\Omega / < 1.5 \text{ nF}$
Sensor supply - pin 44, programmable	$5...17 \text{ V} / 20 \text{ mA}$

TTL input:

Trig-level LOW	$\leq 0.8 \text{ VDC}$
Trig-level HIGH.....	$\geq 2.0 \text{ VDC}$
Input impedance	$\geq 100 \text{ k}\Omega / < 1.5 \text{ nF}$
Sensor supply - pin 44, programmable	$5...17 \text{ V} / 20 \text{ mA}$

S0 input acc. to DIN 43864:

Trig-level LOW	$\leq 2.2 \text{ mA}$
Trig-level HIGH.....	$\geq 9.0 \text{ mA}$
Input impedance	$758 \Omega / < 1.5 \text{ nF}$
Sensor supply - pin 44, fixed.....	17 V

Special voltage input:

User programmable trig-levels.....	$-0.05...6.50 \text{ V}$
Hysteresis, min	50 mV
Input impedance, selectable:	
High Z	$\geq 100 \text{ k}\Omega / < 1.5 \text{ nF}$
Pull up and pull down.....	$3.48 \text{ k}\Omega / < 1.5 \text{ nF}$
Sensor supply - pin 44, programmable.....	$5...17 \text{ V} / 20 \text{ mA}$

Special current input:

User programmable trig-levels.....	$0.0...10.0 \text{ mA}$
Hysteresis, min	0.2 mA
Input impedance	$1 \text{ k}\Omega / < 1.5 \text{ nF}$
Sensor supply - pin 44, programmable	$5...17 \text{ V} / 20 \text{ mA}$

Output:

Display:

Display readout.....	-1999...9999 (4 digits)
Decimal point.....	Programmable
Digit height	13.8 mm
Display updating	2.2 times / s
Input frequency outside range and NAMUR input sensor error is indicated by	Explanatory text

Current output (5725D):

Programmable signal ranges.....	0...20, 4...20 & 20...0, 20...4 mA
Load (max.).....	20 mA / 800 Ω / 16 VDC
Current limit	\leq 28 mA
Load stability	\leq 0.01% of span / 100 Ω
Programmable response time.....	0.1...60.0 s
Sensor error indication, at NAMUR input: selectable	0 / 3.5 / 23 mA / none
Output limitation at outside range: on 4...20 and 20...4 mA signals.....	3.8...20.5 mA
on 0...20 and 20...0 mA signals.....	0...20.5 mA

Relay outputs (5725D):

Relay function.....	Setpoint
Hysteresis, in % / display counts	0...100% / 0...9999
On and Off delay.....	0...3600 s
Power On delay	0.0...60.0 s
Sensor error action.....	Make / Break / Hold
Max. voltage	250 VRMS
Max. current.....	2 A / AC
Max. AC power	500 VA
Max. current at 24 VDC.....	1 A

Marine:

Det Norske Veritas, Ships & Offshore	Stand. f. Certific. No. 2.4
--	-----------------------------

Approvals:

EMC 2014/30/EU.....	EN 61326-1
LVD 2014/35/EU	EN 61010-1
UL, Standard for Safety	UL 508
EAC TR-CU 020/2011.....	EN 61326-1

Sensor error indication, inside and outside range

Sensor error indication in 5725, only available for NAMUR input:				
Condition	Out of range limit	Relay behaviour	Analog output value	Display readout
Sensor input type = NAMUR and sensor error detection = ON	> 6.9 mA	Set to user defined value: HOLD. ACTIVE. DEACTIVE or NONE	Set to user-defined value (23, 0, 3.5 mA or NONE)	"SE.SH"
	< 0.1 mA			"SE.BR"

Input "out of range" indication		
Valid measurement range:	Out of range limit	Display readout
f to I function: 0.001 Hz to 50 kHz	< 0.0009 Hz (18 min. 31 sec.) or 0.5 Hz (2.0 s) if L.COF=YES (Low cut-off frequency)	If In.Lo is set to 0.000 Hz: "0.0" If In.Lo is set \geq 0.001 Hz: "IN.LO" - flashing
	> 50.5 kHz	"IN.HI" - flashing
Period time function: 20 μ s to 999.9 s	> 1111 s (18 min. 31 sec.) (Low cut off time)	"IN.HI" - flashing
	< 19.8 μ s	"IN.LO" - flashing

Display out of range Indication		
Valid display value range:	Out of range limit	Display readout
-1999 to 9999	< -1999	"-1.9.9.9." - flashing
	> 9999	"9.9.9.9." - flashing

Hardware error indication		
Error explanation	Error cause	Display readout
Error in internal communication (SPI etc.)	Permanent error in intercommunication between microcontrollers	"HW.ER" - flashing
Error in checksum test of the configuration in RAM	Error in RAM	"RA.ER" - flashing
Error in checksum test of the configuration in EEPROM	Error in EEPROM	"EE.ER" - flashing
Error in OK check or checksum test of the calibration data in FLASH	Error in FLASH or Calibration has not been performed or Calibration data in FLASH are corrupt	"NO.CA" - flashing

! Error indications in the display blink once a second. The help text explains the error.

CONNECTIONS

Supply:

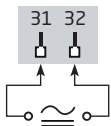

Inputs:

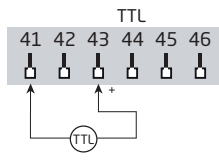
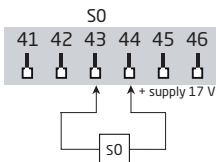
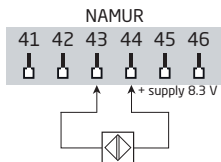
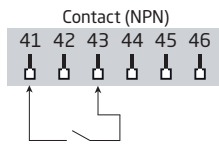
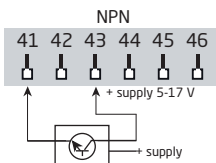
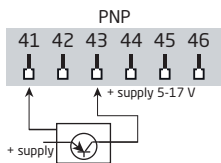
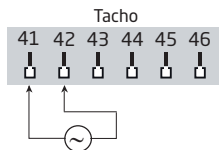
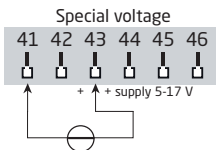
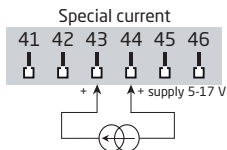

Output:

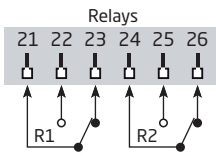
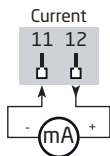

BLOCK DIAGRAM

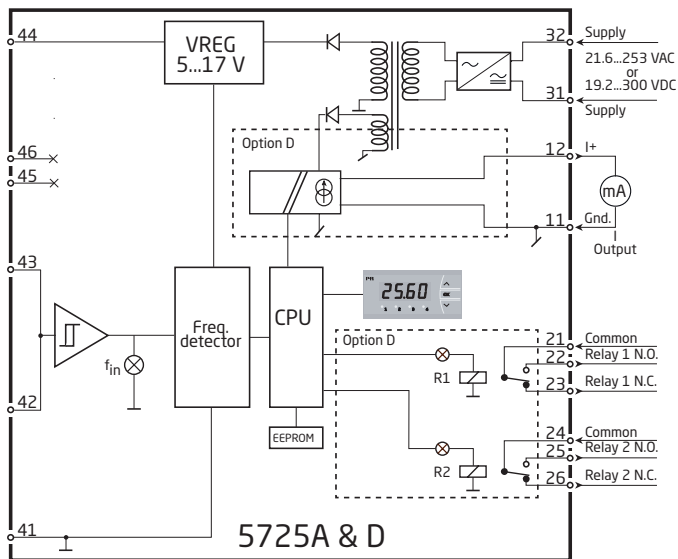



CONFIGURATION / OPERATING



THE FUNCTION KEYS

Documentation for the routing diagram

In general

When configuring the display you are guided through all parameters, allowing you to choose the settings which fit the application. For each menu there is a scrolling help text which is automatically shown in the display if no key has been activated for appr. 5 seconds.

Configuration is carried out by way of the 3 function keys   and .





 will increase the numerical value or choose the next parameter.  will decrease the numerical value or choose the previous parameter.  will accept the chosen value and go to the next menu. If a function does not exist in the hardware, all parameters belonging to that function will be skipped in order to make configuration as simple as possible. The configuration will not be saved until the end of the menu structure when the display shows ----.

Pressing and holding  will return to the previous menu or go back to the default state ("Monitor") without saving the changed values or parameters.

If no key is activated for 2 minutes, the display will return to the default state ("Monitor") without saving the changed values or parameters.

Further explanations

Fast setpoint adjustment and relay test (only 5725D)

These menus are interactive and allow you to adjust the setpoints while the display is measuring the input signal. The front LEDs will then indicate when the relays change state, thus easing the setpoint adjustment in many situations. By activating  and  simultaneously, a relay test will be initiated and the relay will change state. The setpoint adjustment will be saved by a quick press of . Holding down  for more that 0.5 seconds will return the display to the default state ("Monitor") without changing the setpoint.

Password protection

Using a password will block access to the menu and parameters.

Default password 2008 allows access to all configuration menus.

5725D only: There are two levels of password protection.

Passwords between 0000 and 4999 allow access to the fast setpoint adjustment and relay test menus (using this password blocks access to all other parts of the menu).

Passwords between 5000 and 9999 block access to all parts of the menu, fast setpoint and relay test (current setpoint is still shown).

Additional 5725 features (from s/n > 121435001)

Out of range indication at f/I function

Out of range min. limit is < 0.0009 Hz / (18 min. 31 sec.).

- if the **In.Lo** value is set to "0.0" Hz the display readout will be "0.0" when the "out of range" min. limit is reached.

- if the **In.Lo** value is set different from "0.0" Hz the display readout will be "In.Lo" - flashing - when the "out of range" min. limit is reached.

Low cut-off filter

The 5725 frequency indicator has a selectable low cut-off filter, which sets the display and output to 0% when the measured frequency is ≤ 0.5 Hz (2 s). This filter allows the display to ignore extremely low frequencies from flowmeters and encoders which are sometimes present when the process is at idle.

Faster analog output

The analog output response time can be adjusted to a fast 0.1 second, allowing the analog output to track faster changing input signals.

ROUTING DIAGRAM FOR 5725A

If no key is activated for 2 minutes, the display returns to default state "Monitor" without saving configuration changes.

⬆ Increase value / choose next parameter

⬇ Decrease value / choose previous parameter

⊗ Accept the chosen parameter and go to the next menu

Hold ⊗ Back to previous menu / return to default state "Monitor" without saving.

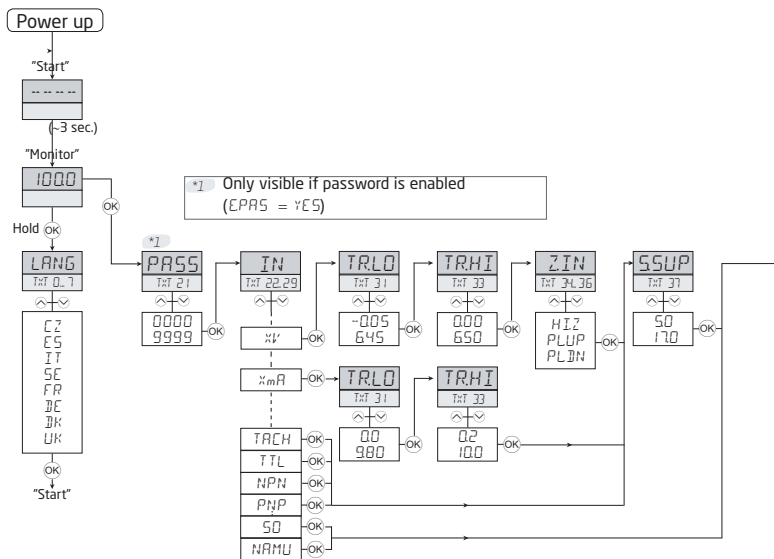

<p>*1 Only visible if password is enabled (EPAS = YES)</p>	<p>*5 Only visible if max. (INLO, INHI) value is ≤ 50 Hz (f/l) or ≥ 20 ms (period time) Default if visible = YES, else deactivated.</p>
<p>*2 *3</p>	<p>*6 *7 *8 *9 Minimum INHI value is automatically limited to 1 display count above INLO</p>
<p>*4 Displays either Hz/kHz or s/ms for 1 sec. before actual value is displayed. When value hits digit-limit while scrolling, either Hz/kHz or s/ms is displayed again for 1 sec. to show the user that the new range is active.</p>	<p>*10 Out of range limit is < 0.0009 Hz (18 min. 31 sec.) when LCOF = NO. Out of range limit is 0.5 Hz (2 sec.) when LCOF = YES.</p>

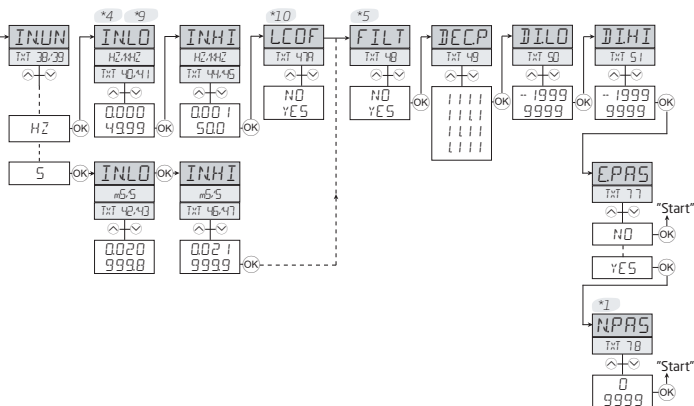

ROUTING DIAGRAM FOR 5725D

If no key is activated for 2 minutes, the display returns to default state "Monitor" without saving configuration changes.

⤴ Increase value / choose next parameter

⤵ Decrease value / choose previous parameter

⊙ Accept the chosen parameter and go to the next menu

Hold ⊙ Back to previous menu / return to default state "Monitor" without saving.

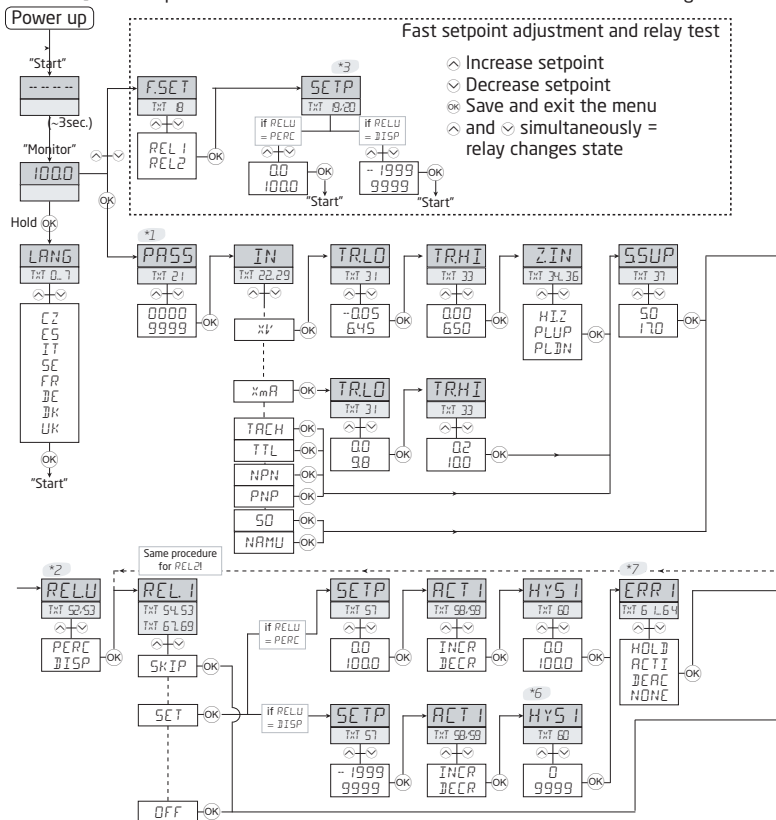

- *1 Only visible if password is enabled (EPAS = YES)
- *2 5725D only
- *3 Password 5000...9999:
FastSet and Relay Test features disabled.
(FastSet menus show the actual setpoints).
- *4 Displays either Hz/kHz or s/ms for 1 sec. before actual value is displayed.
When value hits digit-limit while scrolling, either Hz/kHz or s/ms is displayed again for 1 sec. to show the user that the new range is active.

- *5 Only visible if max. (INLO, INHI) value is ≤ 50 Hz (f/I) or ≥ 20 ms (period time)
Default if visible = YES, else deactivated.
- *6 Range depends on selected display scaling.
- *7 Only visible for NAMUR input.
0mA only visible for ROUT = 0-20 or 20-0
35mA only visible for ROUT = 4-20 or 20-4
- *8 Not visible if both relay functions are OFF.
- *9 Minimum INHI value is automatically limited to 1 display count above INLO
- *10 Out of range limit is < 0.0009 Hz (18 min. 31 sec.) when LCOF = NO.
Out of range limit is 0.5 Hz (2 sec.) when LCOF = YES.

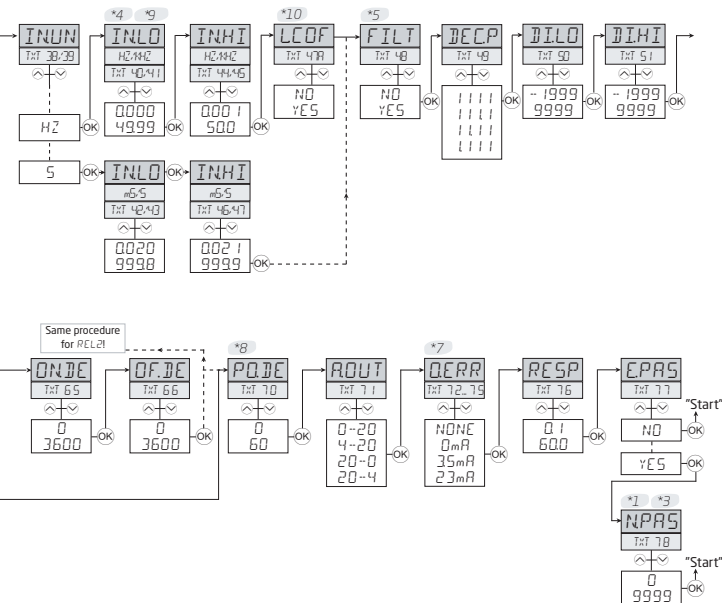

SCROLLING HELP TEXTS

Top line	Scrolling text	TEXT NR
Language menu		
UK	UK - SELECT ENGLISH HELP TEXT	0
DK	DK - VÆLG DANSK HJÆLPETEKST	1
DE	DE - WÄHLE DEUTSCHEN HILFETEXT	2
FR	FR - SÉLECTION TEXTE D'AIDE EN FRANÇAIS	3
SE	SE - VALJ SVENSK HJÄLPTEXT	4
IT	IT - SELEZIONARE TESTI DI AIUTO ITALIANI	5
ES	ES - SELECCIONAR TEXTO DE AYUDA EN ESPANOL	6
CZ	CZ - VYBER ČESKOU NAPOVEDU	7
Error indication (when active, labels are flashing @ appr. 1 Hz)		
SE.BR	SENSOR WIRE BREAKAGE	0
IN.HI	INPUT OVERRANGE	9
SE.SH	SENSOR SHORT CIRCUIT	0
IN.LO	INPUT UNDERRANGE	11
9.9.9.9.	DISPLAY OVERRANGE	12
-1.9.9.9.	DISPLAY UNDERRANGE	13
Hw.ER	HARDWARE ERROR	14
EE.ER	EEPROM ERROR - CHECK CONFIGURATION	15
RA.ER	RAM MEMORY ERROR	16
NO.CA	DEVICE NOT CALIBRATED	17
Fastset Menu		
F.SET		
REL1	FAST SET MENU - SELECT RELAY	0
REL2	FAST SET MENU - SELECT RELAY	0
SETP	(if fastset is enabled)	
xxxx	RELAY SETPOINT - PRESS OK TO SAVE	0
SETP	(if fastset is disabled)	
xxxx	RELAY SETPOINT - READ ONLY	20
Configuration setup		
PASS		
xxxx	SET CORRECT PASSWORD	21
IN		
PNP	PNP SENSOR INPUT	22
NPN	NPN SENSOR INPUT	23
TTL	TTL SENSOR INPUT	24
NAMU	NAMUR SENSOR INPUT	25
SO	SO SENSOR INPUT	26
TACH	TACHO SENSOR INPUT	27
XmA	SPECIAL CURRENT SENSOR INPUT	28
XV	SPECIAL VOLTAGE SENSOR INPUT	29

TR.LO	(when special voltage input is selected)	
xxxx	SET LOW TRIGGER LEVEL IN VOLT	30
TR.LO	(when special current input is selected)	
xxxx	SET LOW TRIGGER LEVEL IN mA	31
TR.HI	(when special voltage input is selected)	
xxxx	SET HIGH TRIGGER LEVEL IN VOLT	32
TR.HI	(when special current input is selected)	
xxxx	SET HIGH TRIGGER LEVEL IN mA	33
Z.IN	(when special voltage input is selected)	
HIZ	SET INPUT RESISTANCE HIGH	34
PLUP	SET INPUT PULL UP	35
PLDN	SET INPUT PULL DOWN	36
S.SUP	(not when NAMUR or SO input is selected)	
xxxx	SET SENSOR SUPPLY VOLTAGE	37
IN.UN		
HZ	SET INPUT UNIT FOR FREQUENCY	38
S	SET INPUT UNIT FOR PERIOD TIME	39
IN.LO		
xxxx	SET INPUT RANGE LOW IN HZ	40
xxxx	SET INPUT RANGE LOW IN KHZ	41
xxxx	SET INPUT RANGE LOW IN S	42
xxxx	SET INPUT RANGE LOW IN mS	43
IN.HI		
xxxx	SET INPUT RANGE HIGH IN HZ	44
xxxx	SET INPUT RANGE HIGH IN KHZ	45
xxxx	SET INPUT RANGE HIGH IN S	46
xxxx	SET INPUT RANGE HIGH IN mS	47
L.COF		
NO	ENABLE LOW CUT OFF	47a
YES	ENABLE LOW CUT OFF	47b
FILT		
NO	ENABLE INPUT FILTER	48
YES	ENABLE INPUT FILTER	48
DEC.P		
1111	DECIMAL POINT POSITION	49
111.1	DECIMAL POINT POSITION	49
11.11	DECIMAL POINT POSITION	49
1.111	DECIMAL POINT POSITION	49

DI.LO		
xxxx	DISPLAY READOUT LOW	50
DI.HI		
xxxx	DISPLAY READOUT HIGH	51
RELU		
PERC	SET RELAY IN PERCENTAGE	52
DISP	SET RELAY IN DISPLAY UNITS	53
REL1		
OFF	RELAY 1 DISABLED	54
SETP	ENTER RELAY 1 SETUP	55
SKIP	SKIP RELAY 1 SETUP	56
SETP		
xxxx	RELAY SETPOINT	57
ACT1		
INCR	ACTIVATE AT INCREASING SIGNAL	58
DECR	ACTIVATE AT DECREASING SIGNAL	59
HYS1		
xxxx	RELAY HYSTERESIS	60
ERR1		
HOLD	HOLD RELAY AT ERROR	61
ACTI	ACTIVATE RELAY AT ERROR	62
DEAC	DEACTIVATE RELAY AT ERROR	63
NONE	UNDEFINED STATUS AT ERROR	64
ON.DE		
xxxx	RELAY ON-DELAY IN SECONDS	65
OF.DE		
xxxx	RELAY OFF-DELAY IN SECONDS	66
REL2		
OFF	RELAY 2 DISABLED	67
SETP	ENTER RELAY 2 SETUP	68
SKIP	SKIP RELAY 2 SETUP	69
SETP		
xxxx	RELAY SETPOINT	57
ACT2		
INCR	ACTIVATE AT INCREASING SIGNAL	58
DECR	ACTIVATE AT DECREASING SIGNAL	59
HYS2		
xxxx	RELAY HYSTERESIS	60

ERR2		
HOLD	HOLD RELAY AT ERROR	61
ACTI	ACTIVATE RELAY AT ERROR	62
DEAC	DEACTIVATE RELAY AT ERROR	63
NONE	UNDEFINED STATUS AT ERROR	64
ON.DE		
xxxx	RELAY ON-DELAY IN SECONDS	65
OF.DE		
xxxx	RELAY OFF-DELAY IN SECONDS	66
PO.DE		
xxxx	RELAY POWER ON DELAY IN SECONDS	70
A.OUT		
20-4	OUTPUT RANGE IN mA	71
20-0	OUTPUT RANGE IN mA	71
4-20	OUTPUT RANGE IN mA	71
0-20	OUTPUT RANGE IN mA	71
O.ERR		
23mA	NAMUR NE43 UPSCALE AT ERROR	72
3.5mA	NAMUR NE43 DOWNSCALE AT ERROR	73
0mA	DOWNSCALE AT ERROR	74
NONE	UNDEFINED OUTPUT AT ERROR	75
RESP		
xxxx	ANALOG OUTPUT RESPONSE TIME IN SECONDS	76
E.PAS		
NO	ENABLE PASSWORD PROTECTION	77
YES	ENABLE PASSWORD PROTECTION	77
N.PAS	(when password enabled)	
xxxx	SELECT NEW PASSWORD	78

Graphic depiction of the relay function setpoint

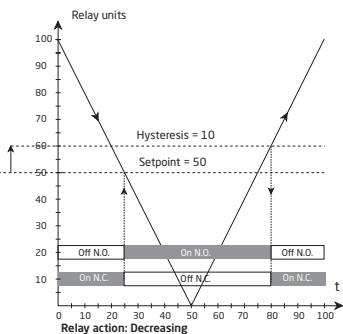
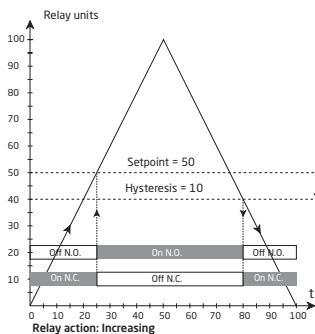



Displays

Programmable displays with a wide selection of inputs and outputs for display of temperature, volume and weight, etc. Feature linearization, scaling, and difference measurement functions for programming via PReset software.



Ex interfaces

Interfaces for analog and digital signals as well as HART signals between sensors / I/P converters / frequency signals and control systems in Ex zone 0, 1 & 2 and for some devices in zone 20, 21 & 22.



Isolation

Galvanic isolators for analog and digital signals as well as HART signals. A wide product range with both loop-powered and universal isolators featuring linearization, inversion, and scaling of output signals.



Temperature



























A wide selection of transmitters for DIN form B mounting and DIN rail devices with analog and digital bus communication ranging from application-specific to universal transmitters.



Universal

PC or front programmable devices with universal options for input, output and supply. This range offers a number of advanced features such as process calibration, linearization and auto-diagnosis.



- 

www.preelectronics.fr

sales-fr@preelectronics.com
- 

www.preelectronics.de

sales-de@preelectronics.com
- 

www.preelectronics.es

sales-es@preelectronics.com
- 

www.preelectronics.it

sales-it@preelectronics.com
- 

www.preelectronics.se

sales-se@preelectronics.com
- 

www.preelectronics.com

sales-uk@preelectronics.com
- 

www.preelectronics.com

sales-us@preelectronics.com
- 

www.preelectronics.cn

sales-cn@preelectronics.com
- 

www.preelectronics.be

sales-be@preelectronics.com

Head office

Denmark
 PR electronics A/S
 Lerbakken 10
 DK-8410 Rønne

www.preelectronics.com
sales-dk@preelectronics.com
 tel. +45 86 37 26 77
 fax +45 86 37 30 85



QUALITY SYSTEM AND ENVIRONMENTAL
 MANAGEMENT SYSTEM
 DS/EN ISO 9001
 DS/EN ISO 14001

